



## Safety instructions



Read these safety instructions and the original instructions before using the device for the first time. Act in accordance with them. Keep the two booklets for future reference or for future owners.

- Prior to initial startup, please observe the graphical operating instructions for your device and these safety instructions.
- In addition to the notes in the operating instructions, you also need to take into consideration the general safety regulations and accident prevention guidelines applicable by law.
- Keep the packaging foil away from children, as this poses a suffocation risk.

### Hazard levels

#### **DANGER**

- Indication of an imminent threat of danger that will lead to severe injuries or even death.

#### **WARNING**

- Indication of a potentially dangerous situation that may lead to severe injuries or even death.

#### **CAUTION**

- Indication of a potentially dangerous situation that may lead to minor injuries.

#### **ATTENTION**

- Indication of a potentially dangerous situation that may lead to damage to property.

### General notes

 **WARNING** • *Persons with reduced physical, sensory or mental capabilities and persons lacking experience and knowledge may only use the appliance if they are properly supervised, have been instructed on use of the appliance safely by a person responsible for their safety, and understand the resultant hazards involved.* • *Children must be supervised to prevent them from playing with the appliance.* • *Children from the minimum age of 8 may use the appliance if they are properly supervised or have been instructed in its use by a person responsible for their safety, and if they have understood the resultant hazards involved.* • *Children may only perform cleaning work and user maintenance under supervision.* • *Children must not play with the appliance.*

### Risk of electric shock

 **DANGER** • *Never touch the mains plug and socket with wet hands.* • *Never touch contacts or lines.* • *Never insert conductive objects, e.g. screwdrivers or similar, into the charging socket on the appliance.* • *Do not expose the battery to strong sunlight, heat or fire.* • *Do not direct the spray jet directly onto consumables containing electrical components, e.g. the interior space of ovens.*

 **WARNING** • *Only charge the appliance using the original charger enclosed or with a charger approved by KÄRCHER.* • *Immediately replace a damaged charger together with charging cable with an original part.* • *Do not charge any damaged battery packs. Replace damaged battery packs with battery packs approved by KÄRCHER. Does not apply to appliances with a fixed battery* • *Only use the charger for charging approved battery packs.* • *The appliance contains elec-*

*trical components - do not clean the appliance under running water.*

**ATTENTION** • *Short circuit hazard. Do not store the battery packs together with metal objects.* • *Only use and store the charger in dry rooms.* • *This device contains non-replaceable batteries. Does not apply to appliances with a replaceable battery pack*

### Operation

 **DANGER** • *Risk of explosion. Do not charge batteries (primary cells).* • *Do not throw battery packs into a fire or into the household rubbish.* • *Avoid contact with fluid leaking from defective batteries. Immediately rinse off the fluid using water if contact is made, and also consult a doctor in the event of contact with the eyes.*

 **WARNING** • *Risk of injury. Do not direct the spray jet onto the eyes.*

 **CAUTION** • *Do not use the appliance if it has been dropped beforehand, is visibly damaged or if it is leaking.*

**ATTENTION** • *Do not introduce any objects into the air outlet.* • *Test the microfibre wiping cloth on a spot that is not noticeable before you use the window cleaner on sensitive (high-gloss) surfaces.* • *Store the appliance only so that it is standing upright.* • *Store the appliance only in dry rooms.* • *Switch off the appliance and empty the die waste water tank when the level in the waste water tank reaches the MAX mark.*

### Intended use

Only use the appliance in private households. The battery-powered appliance is designed for cleaning moist, smooth surfaces such as windows, mirrors or tiles. Observe the safety instructions.

- Never use the appliance for absorbing dust.
- Do not absorb any more than 25 ml of fluid. The appliance is not suitable for absorbing larger quantities of fluid from horizontal surfaces, e.g. from a toppled drinking glass.
- Only use the appliance in combination with regular window cleaning agents (no spirits, no foam cleanser).
- Only use the appliance with accessories and spare parts approved by KÄRCHER.

Any other use is deemed as contrary to the designated use. The manufacturer shall not be responsible for any damages that may result thereby; the risk is borne solely by the user.

### Symbols

#### Symbols on the device



(according to type of appliance)



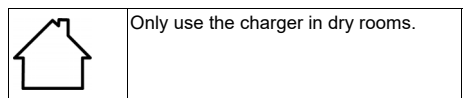



Charge the battery only using the original charger enclosed or with a charger approved by KÄRCHER.







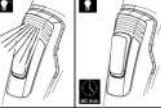
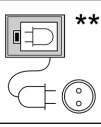
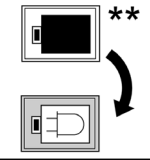
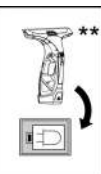

## Only for appliances with removable battery

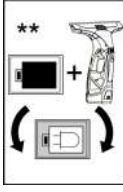
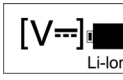
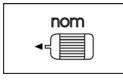
	Do not throw the battery into fire
	Do not throw the battery into water

### Symbols used in the operating instructions

	Charging time for an empty battery
	Waste water tank capacity
	Operating time when battery is fully charged
	Charger output voltage / output current
	
	<b>Symbols according to unit type</b> When the battery is fully charged, the LEDs light up for 60 minutes and then go out
<b>**</b>	<b>Optional accessories</b> Consisting of charging station and battery, depending on equipment
	Connect the charging station to the power cable and plug it into a mains socket
	Put the battery into the charging station
	Put the appliance into the charging station <b>Note</b> <i>The battery must be in the appliance when charging.</i>

	Put the replaceable battery and appliance into the charging station at the same time <b>Note</b> <i>The battery must be in the appliance when charging. The battery in the appliance is fully charged first. The appliance is ready for operation. After that, the charging station will start to charge the replaceable battery.</i>
	Nominal voltage of battery
	Nominal power of device
	Energy consumption
	Battery capacity
	Protection class
	Weight
	Sound level (EN 60704-2-1)

### Scope of delivery

The scope of delivery for the appliance is shown on the packaging. Check the contents for completeness when unpacking. If any accessories are missing or in the event of any shipping damage, please notify your dealer.

### Environmental protection



The packing materials can be recycled. Please dispose of packaging in accordance with the environmental regulations.



Electrical and electronic devices contain valuable, recyclable materials and often components such as batteries, rechargeable batteries or oil, which - if handled or disposed of incorrectly - can pose a potential danger to human health and the environment. However, these components are required for the correct operation of the device. Devices marked by this symbol are not allowed to be disposed of together with the household rubbish.

### Notes on the content materials (REACH)

Current information on content materials can be found at: [www.kaercher.de/REACH](http://www.kaercher.de/REACH)

## **Transportation**

The battery has been tested in accordance with the relevant rules for international transport, and can be transported / shipped.

## **Warranty**

The warranty conditions issued by our sales company responsible apply in all countries. We shall remedy possible malfunctions on your device within the warranty period free of cost, provided that a material or manufacturing defect is the cause. In a warranty case, please contact your dealer (with the purchase receipt) or the next authorised customer service site.  
(See overleaf for the address)

## **Accessories and spare parts**

Only use original accessories and original spare parts. They ensure that the appliance will run fault-free and safely.  
Information on accessories and spare parts can be found at [www.kaercher.com](http://www.kaercher.com).

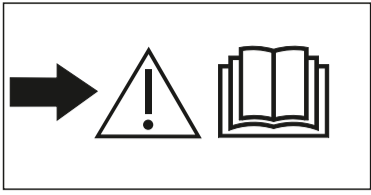

WV 2

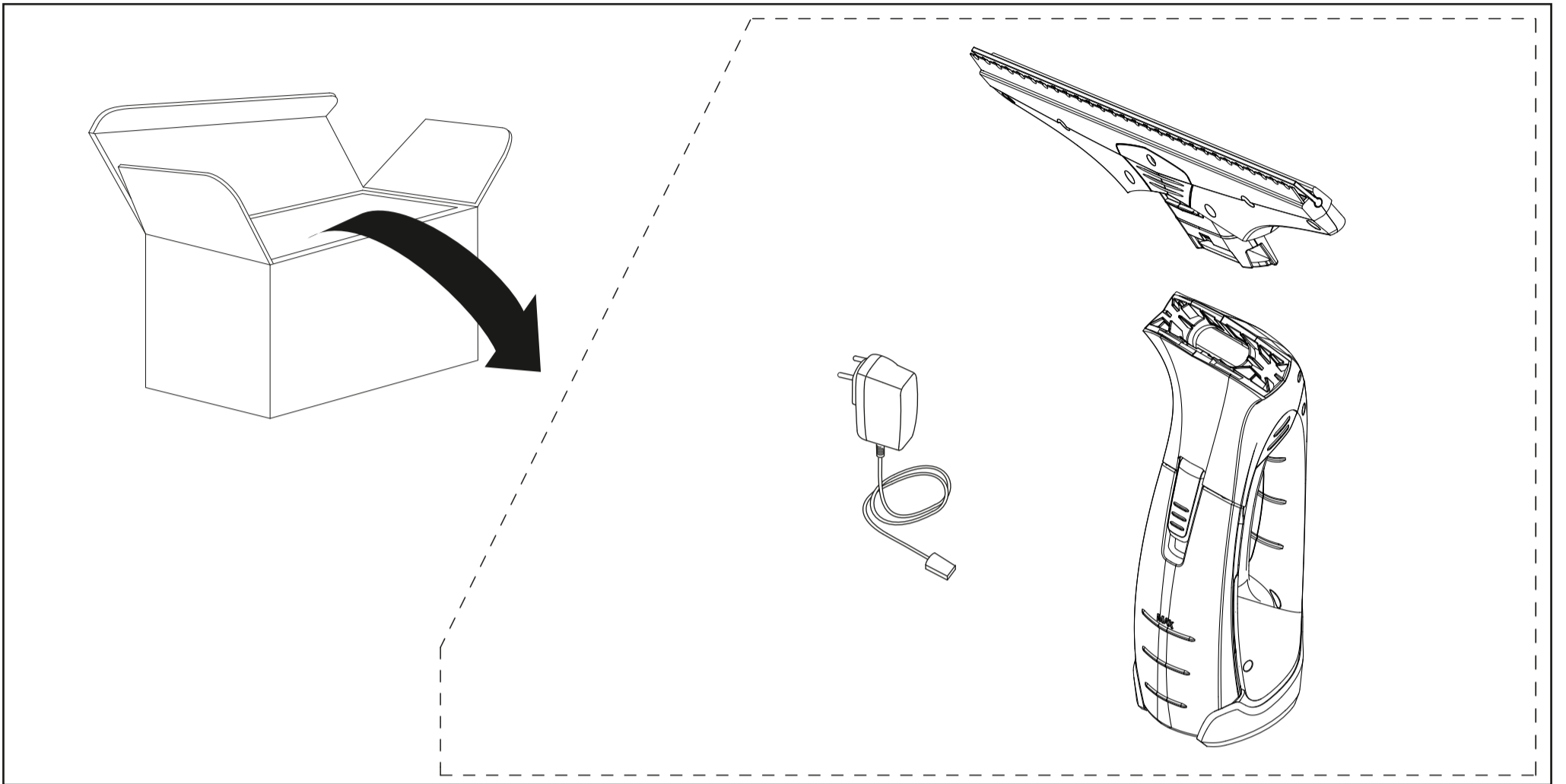

<p>[V=] Li-Ion</p>	<p>3,6 V 3,7 V</p>		<p>IPX4</p>		<p>0,6 kg</p>
<p>nom</p>	<p>10 W</p>		<p>100 ml</p>		<p>230 min</p>
	<p>5,5 V 600 mA</p>		<p>50 db(A)</p>		<p>35 min</p>

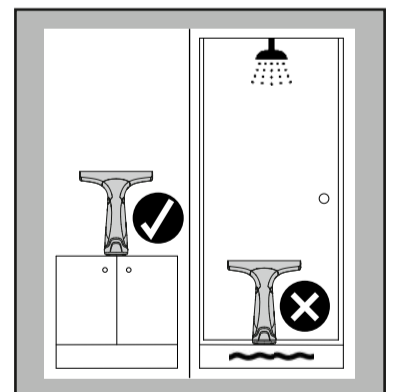
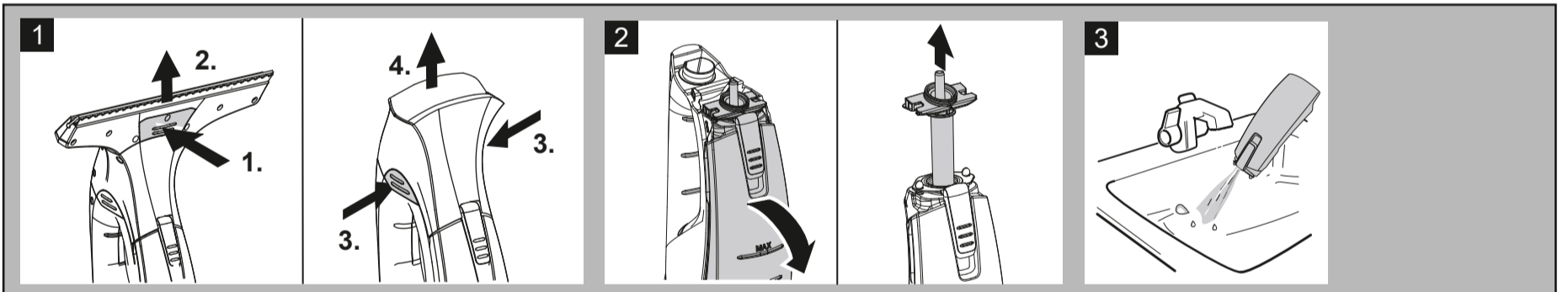
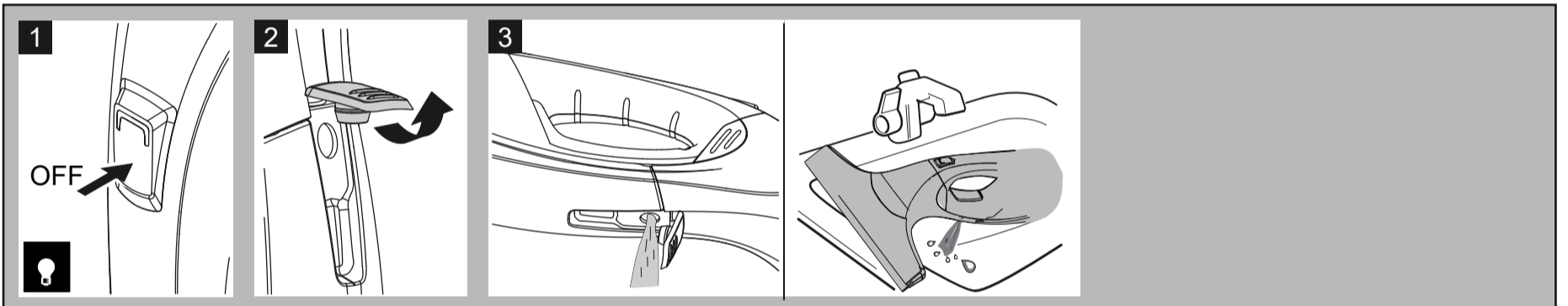
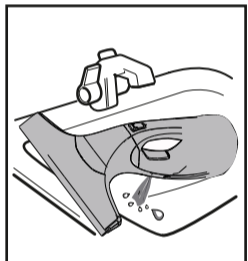
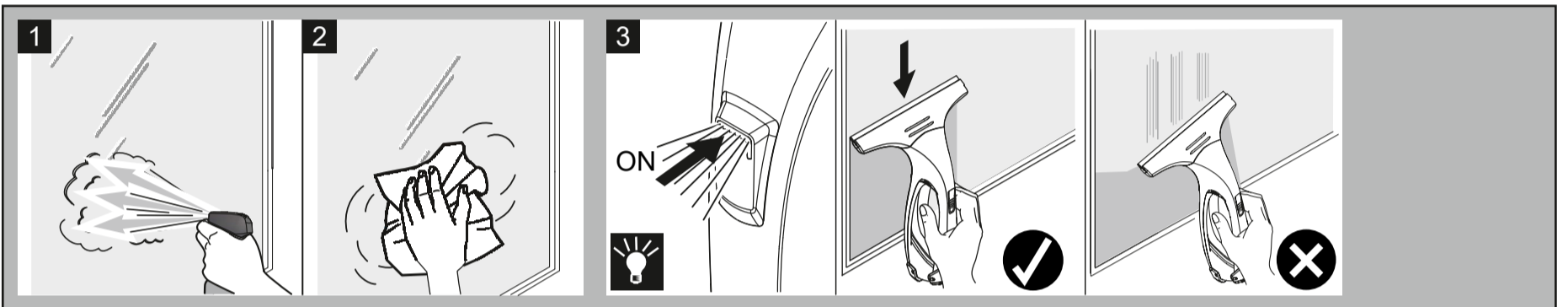
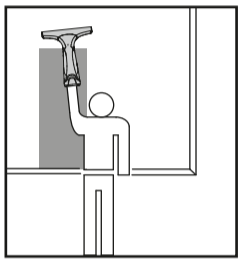
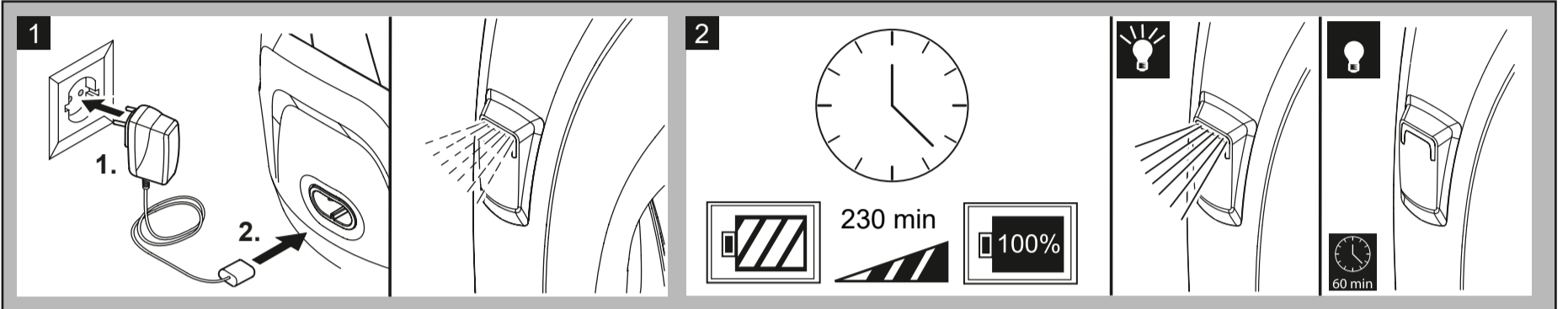
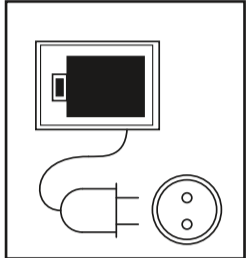
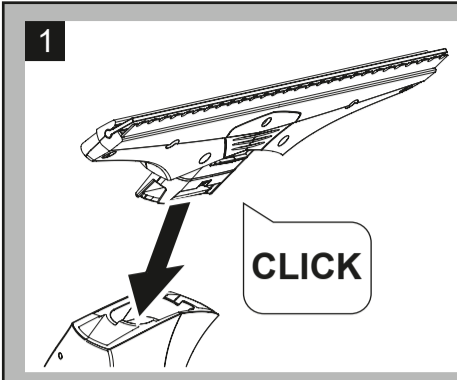
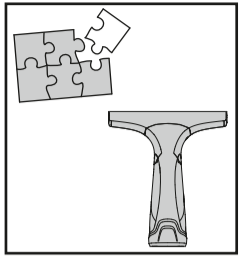



**THANK YOU!**  
**MERCI! DANKE! ¡GRACIAS!**



Registrieren Sie Ihr Produkt und profitieren Sie von vielen Vorteilen.

Register your product and benefit from many advantages.

Enregistrez votre produit et bénéficiez de nombreux avantages.

Registre su producto y aproveche de muchas ventajas.

**[www.kaercher.com/welcome](http://www.kaercher.com/welcome)**



Bewerten Sie Ihr Produkt und sagen Sie uns Ihre Meinung.

Rate your product and tell us your opinion.

Évaluer votre produit et dites-nous votre opinion.

Reseñe su producto y díganos su opinión.



**[www.kaercher.com/dealersearch](http://www.kaercher.com/dealersearch)**

**Alfred Kärcher SE & Co. KG**

Alfred-Kärcher-Str. 28-40

71364 Winnenden (Germany)

